

CURVED VANE SWIRL DIFFUSER

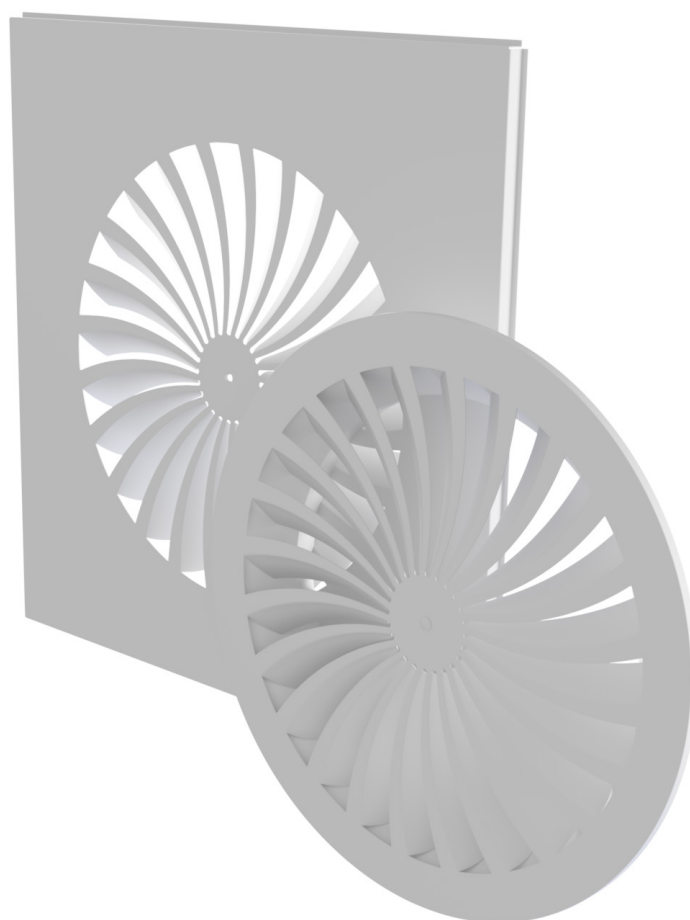

CURVED VANE SWIRL DIFFUSER

CSW Curved vane swirl diffusers are suitable for ceiling mounting and can be manufactured to suit most ceiling tile arrangements.

The CSW curved vane swirl diffuser offers excellent induction of room air and the rapid decay of supply air velocities and air temperature differentials.

Available in square or circular formats, the CSW can be manufactured to suit standard lay-in, tegular and clip-in ceiling systems.

CSW swirl diffusers are also suitable for exposed ceiling applications.

Bespoke plenum boxes can be supplied to suit and are available in either galvanized or painted finish and with acoustic & thermal foam lining.

Tegular frame options are available to suit most ceiling systems



CSW-24-L Lay-in Ceiling

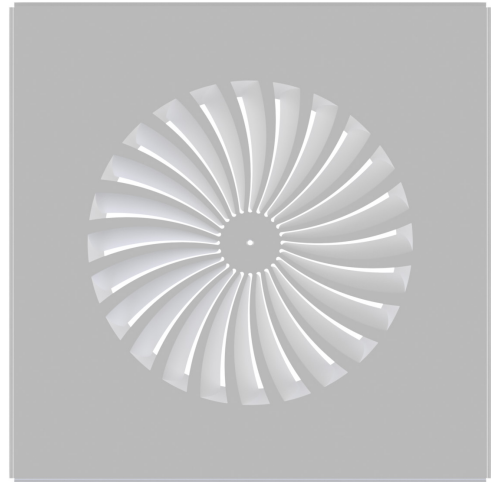

CSW-24-C Circular Type

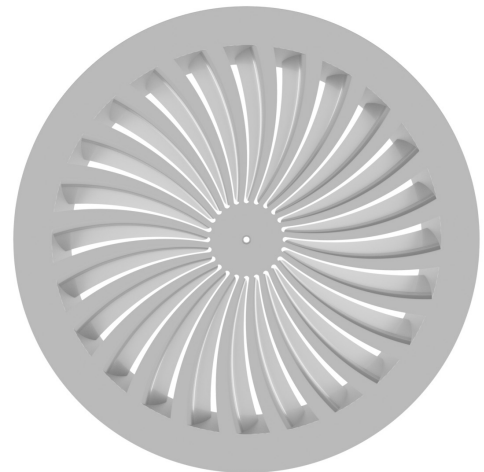

CSW-24-C Circular Exposed Ceiling Type



Frame Options, Dimensional Information & Ordering

CSW-24-L Lay-in Ceiling Type

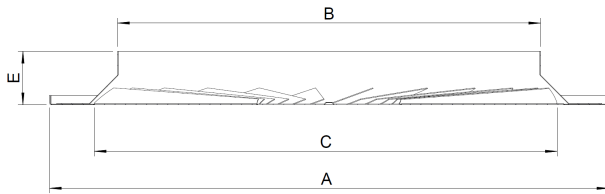

Nom Size	A	B ϕ	C ϕ	E
350	595	347	400	55
450	595	447	500	55

CSW-24-C Circular Type

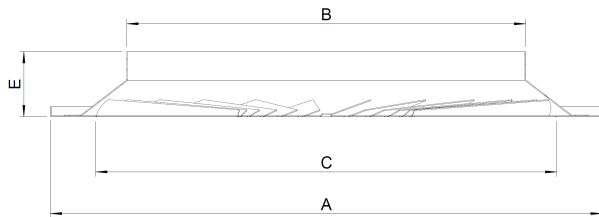

Nom Size	A ϕ	B ϕ	C ϕ	E
350	480	347	400	55
450	590	447	500	55

CSW-24-T Tegular Ceiling Type

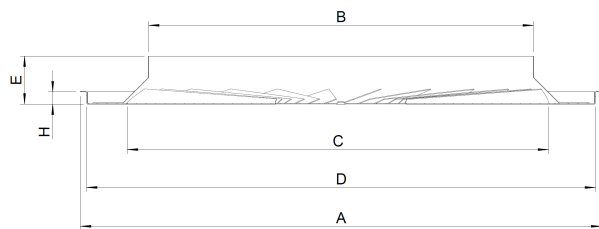

Nom Size	A ϕ	B ϕ	C ϕ	D 24T/15T	E
350	595	347	400	574 - 584	55
450	595	447	500	574 - 584	55

CSW-24-M Clip-in Metal Ceiling Type

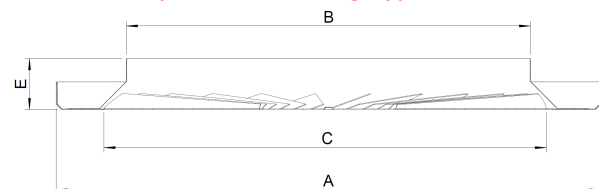

Nom Size	A	B ϕ	C ϕ	E
350	599	347	400	55
450	599	447	500	55

Ordering

Type	No of Blades	Edge Detail	Tegular Depth	Size	Overall Size	RAL Colour
CSW	24	L - Lay-in Grid		350	595x595	
		T15 - Tegular 584x584	e.g. 8mm	450	599x599	e.g. RAL9010
		T24 - Tegular 574x574				
		M - Clip-in Metal Tile				

e.g. 10no. CSW-24-L-450-595x595-RAL9010

Plenum Box Dimensions & Standards

All plenum boxes are available with 6mm or 12mm Class 'O' foam lining. Additional spigots and bespoke boxes are available on request, please contact the Sales Office to discuss your requirements.

Circular Plenums

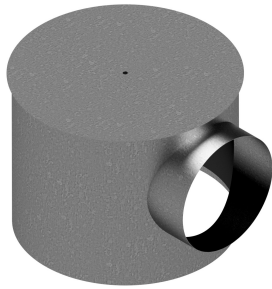
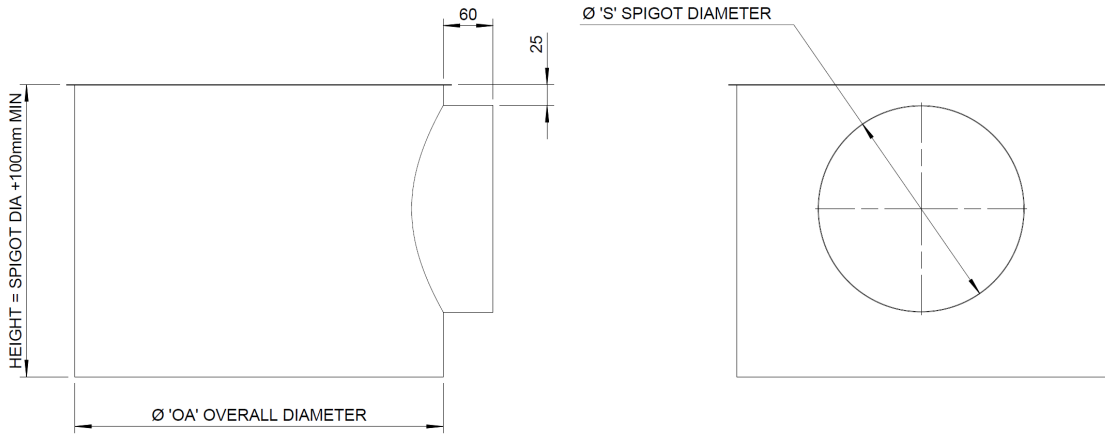

Nom Diffuser Size	OA Ceiling Type	OA Exposed Type
350	350	478
450	450	588

Square Plenums

Tapered boxes are supplied as standard, straight sided boxes are available on request.

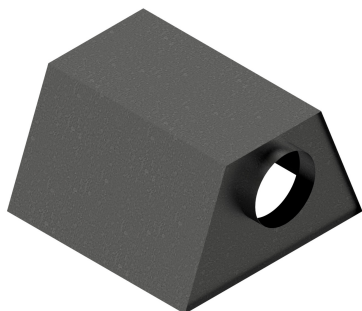
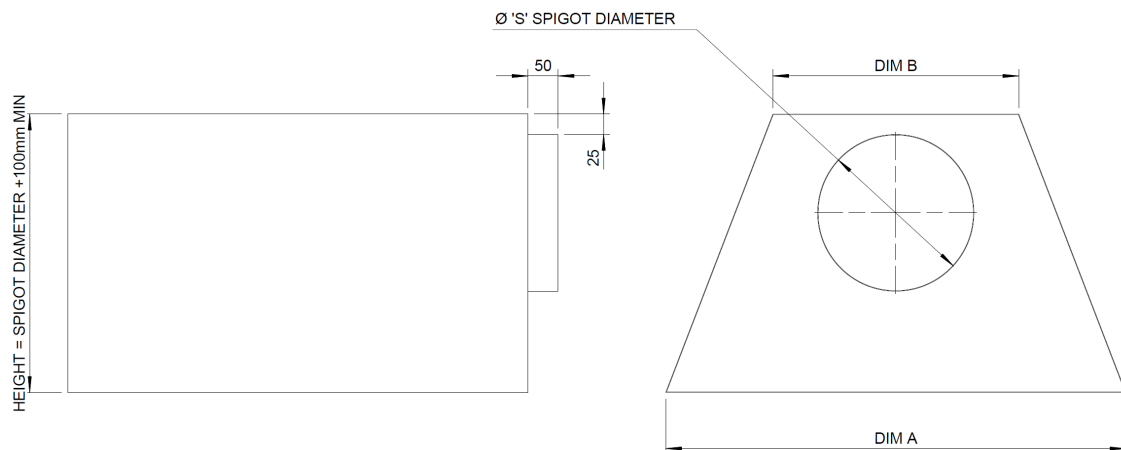

Nom Diffuser Size	DIM A	DIM B
350	474	310
450	564	310

Performance Data

350 Dia	I/s	50	55	60	65	70	80	90	100	110
	Throw m	0.8-1.6	0.8-1.7	1.0-1.9	1.1-2.0	1.1-2.2	1.2-2.5	1.5-2.8	1.5-3.1	1.5-3.4
	Pa	4	4	5	6	7	9	12	14	17
	NC						17	20	23	26
	I/s	120	130	140	150	160	170	180	190	200
	Throw m	1.8-3.8	2.0-4.1	2.1-4.4	2.3-4.7	2.4-5.0	2.5-5.3	2.8-5.6	2.4-5.9	3.0-6.3
	Pa	21	24	28	32	36	41	46	51	57
	NC	28	31	33	35	36	38	40	41	43
450 Dia	I/s	75	80	90	100	110	120	130	140	150
	Throw m	0.8-1.8	0.9-1.9	1.0-2.2	1.1-2.4	1.2-2.6	1.4-2.9	1.5-3.1	1.6-3.4	1.8-3.6
	Pa	5	6	7	9	11	13	15	18	20
	NC					16	18	21	23	25
	I/s	160	170	180	190	200	210	220	230	240
	Throw m	1.8-3.8	2.0-4.1	2.1-4.3	2.3-4.6	2.4-4.8	2.4-5.0	2.5-5.3	2.7-5.5	2.8-5.8
	Pa	23	26	29	33	36	40	44	48	52
	NC	26	28	30	31	33	34	35	37	38

NOTE:

All throws based on terminal velocities of 0.5-0.25 m/s

For Return Air Applications Multiply Pa x 0.75, NC Levels remain the same